

NCP706B, NCP706AB

1 A, 1% Precision Very Low Dropout Voltage Regulator with Enable

The NCP706B/AB are a Very Low Dropout Regulators family which provides up to 1 A of load current and maintains excellent output voltage accuracy of 1% including line, load and temperature variations. The operating input voltage range from 2.4 V up to 5.5 V makes this device suitable for Li-ion battery powered products as well as post-regulation applications. The product is available in 3.0 V fixed output voltage option. NCP706B/AB are fully protected against overheating and output short circuit and includes latched OCP protection which automatically latches-off the device in the case of a short circuit event and the NCP706AB has internal active discharge circuit.

Very small 8-pin XDFN8 1.6 x 1.2, 04P package makes the device especially suitable for space constrained portable applications such as tablets and smartphones. Parts feature active output discharge function.

Features

- Operating Input Voltage Range: 2.4 V to 5.5 V
- Fixed Output Voltage Option: 3.0 V
Other Output Voltage Options Available on Request.
- Low Quiescent Current of Typ. 200 μ A
- Very Low Dropout: 155 mV at $I_{OUT} = 1$ A
- $\pm 1\%$ Accuracy Over Load/Line/Temperature
- High PSRR: 58 dB at 1 kHz
- Internal Soft-Start to Limit the Inrush Current
- Thermal Shutdown and Current Limit Protections
- Stable with a 2.2 μ F Ceramic Output Capacitor
- Active Output Discharge (NCP706AB)
- Available in XDFN8 1.6 x 1.2, 04P 8-pin Package
- Latched Overcurrent Protection
- These are Pb-Free Devices

Typical Applications

- Tablets, Smartphones,
- Wireless Handsets, Portable Media Players
- Portable Medical Equipment
- Other Battery Powered Applications

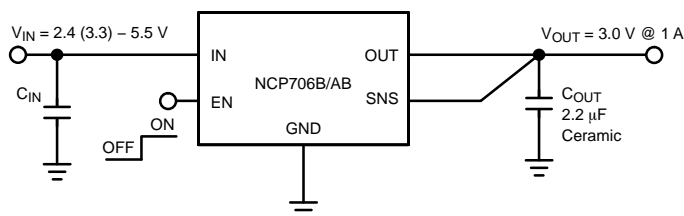

Figure 1. Typical Application Schematic



ON Semiconductor®

<http://onsemi.com>



XDFN8
CASE 711AS

MARKING DIAGRAM

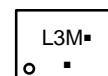

L3 = Specific Device Code
M = Date Code
▪ = Pb-Free Package

(Note: Microdot may be in either location)

PIN CONNECTION

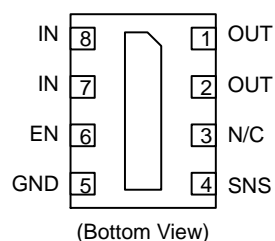
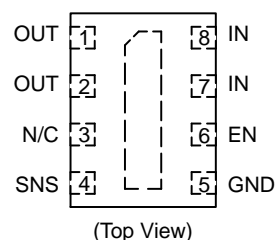

ORDERING INFORMATION

See detailed ordering, marking and shipping information on page 9 of this data sheet.

NCP706B, NCP706AB

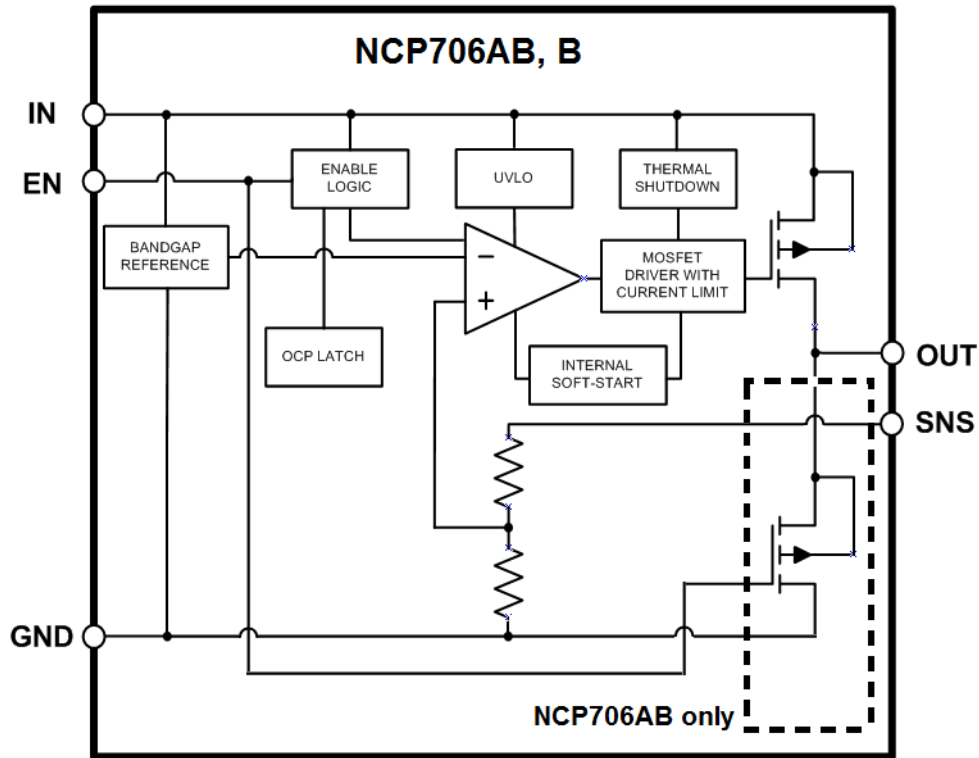

Figure 2. Simplified Internal Schematic Block Diagram

PIN FUNCTION DESCRIPTION

Pin No. XDFN8	Pin Name	Description
1	OUT	Regulated output voltage. A minimum 2.2 μ F ceramic capacitor is needed from this pin to ground to assure stability.
2	OUT	
3	N/C	Not connected. This pin can be tied to ground to improve thermal dissipation.
4	SNS	Remote sense connection. This pin should be connected to the output voltage rail.
5	GND	Power supply ground.
6	EN	Enable pin. Driving EN over 0.9 V turns on the regulator. Driving EN below 0.4 V puts the regulator into shutdown mode. In case of the NCP706B/AB pulling the EN low resets the OCP latch state.
7	IN	Input pin. A small capacitor is needed from this pin to ground to assure stability.
8	IN	
-	Exposed Pad	This pad enhances thermal performance and is electrically connected to GND. It is recommended that the exposed pad is connected to the ground plane on the board or otherwise left open.

NCP706B, NCP706AB

ABSOLUTE MAXIMUM RATINGS

Rating	Symbol	Value	Unit
Input Voltage (Note 1)	V_{IN}	-0.3 V to 6 V	V
Output Voltage	V_{OUT}	-0.3 V to $V_{IN} + 0.3$ V	V
Enable Input	V_{EN}	-0.3 V to $V_{IN} + 0.3$ V	V
Output Short Circuit Duration	t_{SC}	Indefinite	s
Maximum Junction Temperature	$T_{J(MAX)}$	150	°C
Storage Temperature	T_{STG}	-55 to 150	°C
ESD Capability, Human Body Model (Note 2)	ESD _{HBM}	2000	V
ESD Capability, Machine Model (Note 2)	ESD _{MM}	200	V

Stresses exceeding those listed in the Maximum Ratings table may damage the device. If any of these limits are exceeded, device functionality should not be assumed, damage may occur and reliability may be affected.

1. Refer to ELECTRICAL CHARACTERISTICS and APPLICATION INFORMATION for Safe Operating Area.
2. This device series incorporates ESD protection and is tested by the following methods:
 - ESD Human Body Model tested per EIA/JESD22-A114
 - ESD Machine Model tested per EIA/JESD22-A115
 - Latch-up Current Maximum Rating tested per JEDEC standard: JESD78

THERMAL CHARACTERISTICS

Rating	Symbol	Value	Unit
Thermal Characteristics, XDFN8 1.6x1.2, 04P Thermal Resistance, Junction-to-Air	$R_{\theta JA}$	160	°C/W

NCP706B, NCP706AB

ELECTRICAL CHARACTERISTICS – VOLTAGE VERSION 3.0 V

–40°C ≤ T_J ≤ 125°C; V_{IN} = V_{OUT(NOM)} + 0.3 V or 3.3 V, whichever is greater; I_{OUT} = 10 mA, C_{IN} = C_{OUT} = 2.2 μF, V_{EN} = 0.9 V, unless otherwise noted. Typical values are at T_J = +25°C. (Note 3)

Parameter	Test Conditions	Symbol	Min	Typ	Max	Unit
Operating Input Voltage		V _{IN}	2.4		5.5	V
Undervoltage lock-out	V _{IN} rising, I _{OUT} = 0	UVLO	1.2	1.6	1.9	V
Output Voltage Accuracy	V _{OUT} + 0.3 V ≤ V _{IN} ≤ 4.5 V, I _{OUT} = 0 – 1 A	V _{OUT}	2.97	3.0	3.03	V
Line Regulation	V _{OUT} + 0.3 V ≤ V _{IN} ≤ 4.5 V, I _{OUT} = 10 mA	Reg _{LINE}		2		mV
Load Regulation	I _{OUT} = 0 mA to 1 A, V _{IN} = 3.3 V	Reg _{LOAD}		2		mV
Load Transient	I _{OUT} = 10 mA to 1 A in 10 μs, V _{IN} = 3.5 V C _{OUT} = 10 μF	Tran _{LOAD}		±120		mV
Dropout voltage (Note 4)	I _{OUT} = 1 A, V _{OUT(nom)} = 3.0 V	V _{DO}		155	230	mV
Output Current Limit	V _{OUT} = 90% V _{OUT(nom)}	I _{CL}	1.1			A
Quiescent current	I _{OUT} = 0 mA	I _Q		170	230	μA
Ground current	I _{OUT} = 1 A	I _{GND}		200		μA
Shutdown current	V _{EN} = 0 V, V _{IN} = 2.0 to 5.5 V			0.1	1	μA
EN Pin High Threshold EN Pin Low Threshold	V _{EN} Voltage increasing V _{EN} Voltage decreasing	V _{EN_HI} V _{EN_LO}	0.9		0.4	V
EN Pin Input Current	V _{EN} = 5.5 V	I _{EN}		300	700	nA
Overcurrent Protection Blanking Time (Note 5)	V _{OUT} = V _{OUT(nom)} down to V _{OUT} = 0V (Output Shorted to GND)	t _{BLANK}		10		ms
Turn-on Time	C _{OUT} = 2.2 μF, from assertion EN pin to 98% V _{out(nom)}	t _{ON}		150		μs
Power Supply Rejection Ratio	V _{IN} = 3.5 V + 200 mVpp modulation, V _{OUT} = 3.0 V I _{OUT} = 0.5 A, C _{OUT} = 4.7 μF	PSRR		65 58 52		dB
Output Noise Voltage	V _{OUT} = 3.0 V, V _{IN} = 4.0 V, I _{OUT} = 0.5 A f = 100 Hz to 100 kHz	V _{NOISE}		300		μV _{rms}
Thermal Shutdown Temperature	Temperature increasing from T _J = +25°C	T _{SD}		160		°C
Thermal Shutdown Hysteresis	Temperature falling from T _{SD}	T _{SDH}		20		°C
Active Output Discharge (NCP706AB only)	V _{EN} ≤ 0.4 V, V _{IN} = 4.5 V	R _{DIS}		60		Ω

Product parametric performance is indicated in the Electrical Characteristics for the listed test conditions, unless otherwise noted. Product performance may not be indicated by the Electrical Characteristics if operated under different conditions.

3. Performance guaranteed over the indicated operating temperature range by design and/or characterization production tested at T_J = T_A = 25°C. Low duty cycle pulse techniques are used during testing to maintain the junction temperature as close to ambient as possible.
4. Characterized when V_{OUT} falls 90 mV below the regulated voltage at V_{IN} = 3.3 V, I_{OUT} = 10 mA.
5. For more information see APPLICATIONS INFORMATION section on page 8.

NCP706B, NCP706AB

TYPICAL CHARACTERISTICS

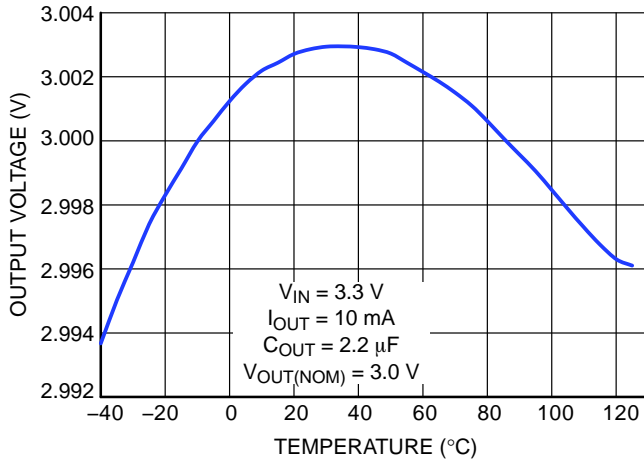

Figure 3. Output Voltage vs. Temperature

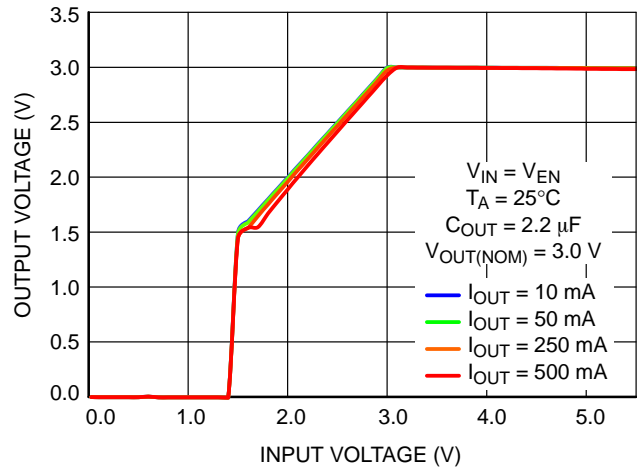

Figure 4. Output Voltage vs. Input Voltage

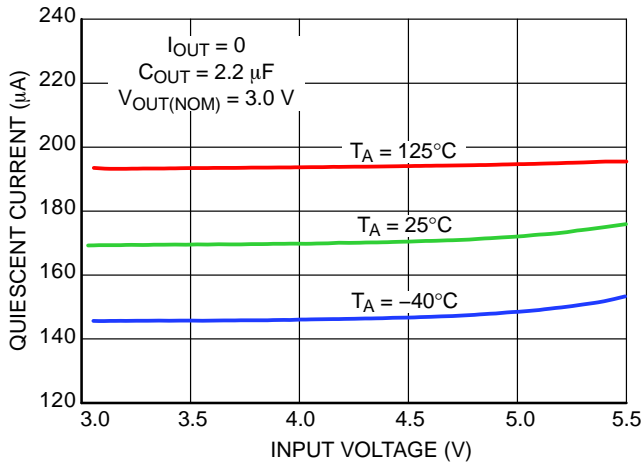

Figure 5. Quiescent Current vs. Input Voltage

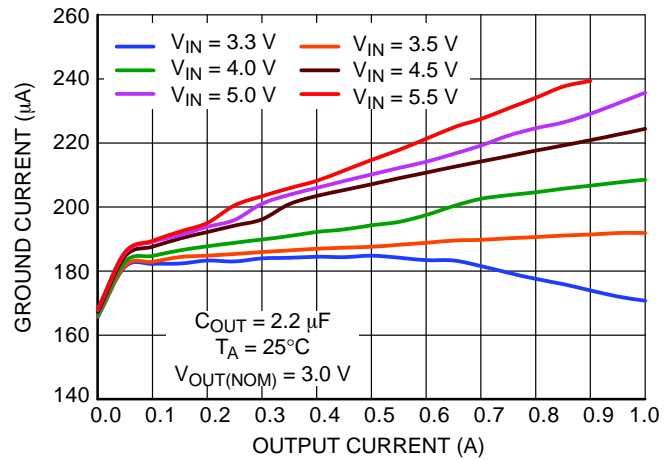

Figure 6. Ground Current vs. Output Current

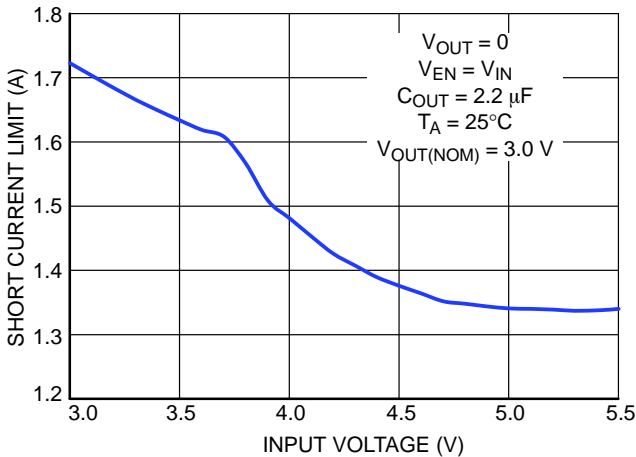

Figure 7. Short Current Limitation vs. Input Voltage

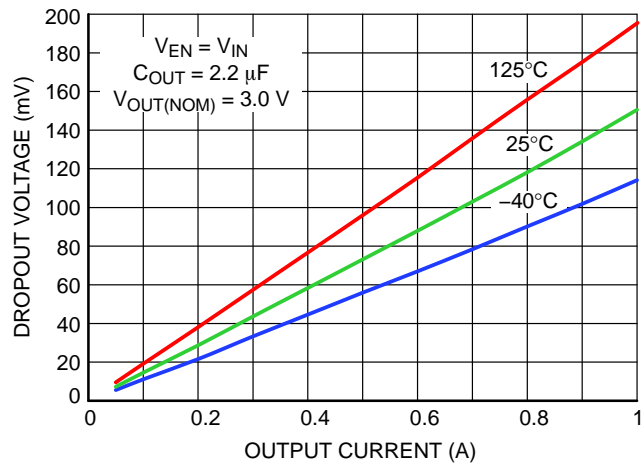

Figure 8. Dropout Voltage vs. Output Current

NCP706B, NCP706AB

TYPICAL CHARACTERISTICS

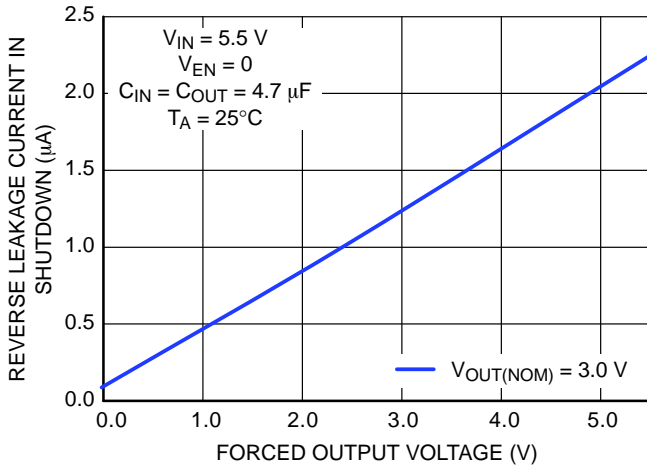

Figure 9. Reverse Leakage Current in Shutdown

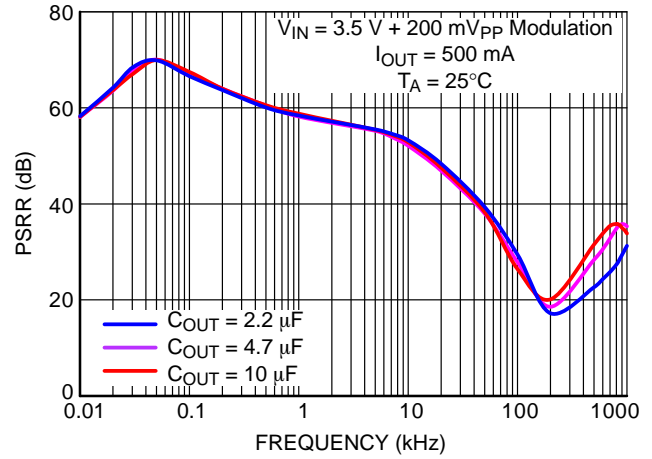

Figure 10. PSRR vs. Frequency & Output Capacitor

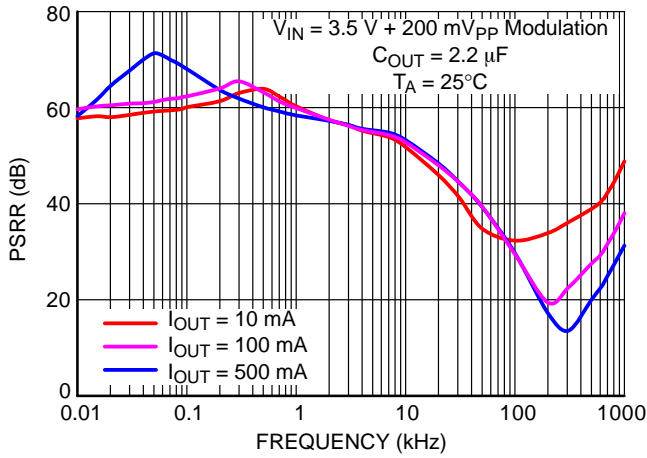

Figure 11. PSRR vs. Frequency & Output Current

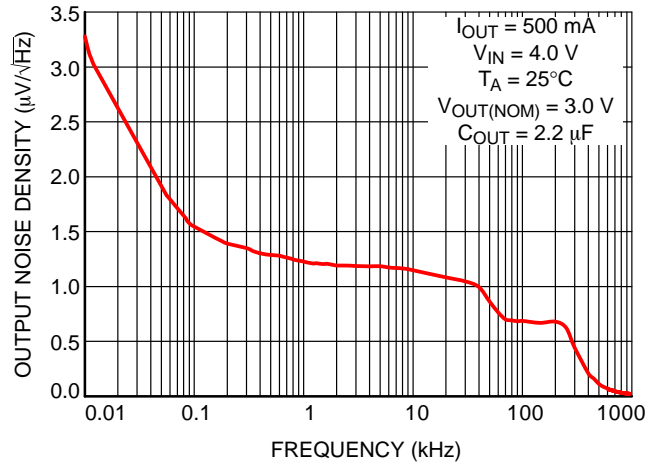

Figure 12. Output Noise Density vs. Frequency

NCP706B, NCP706AB

TYPICAL CHARACTERISTICS

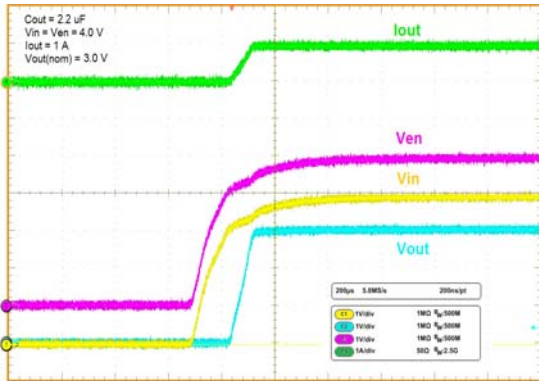

Figure 13. Turn-on by Coupled Input and Enable Pins

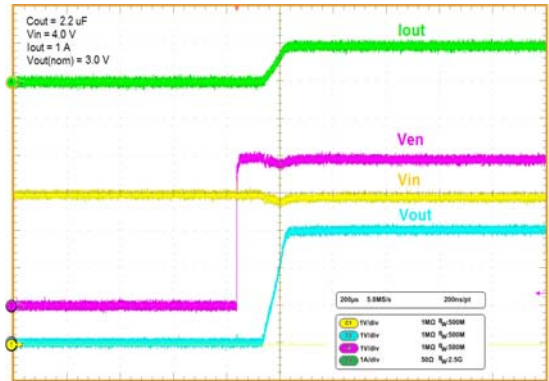

Figure 14. Turn-on by Enable Signal

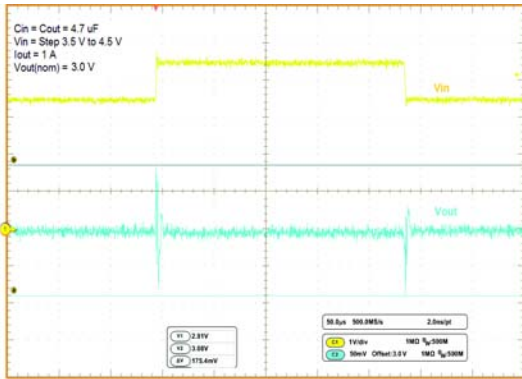

Figure 15. Line Transient Response

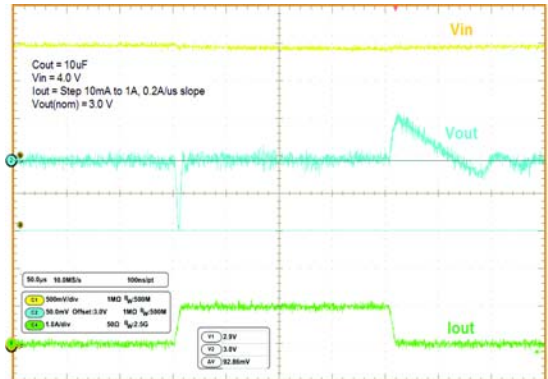

Figure 16. Load Transient Response

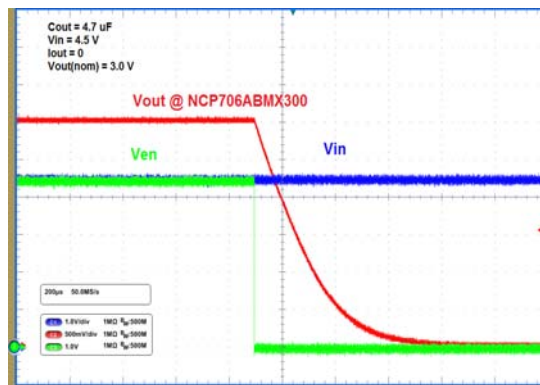

Figure 17. Turn-off by Enable Signal

NCP706B, NCP706AB

APPLICATIONS INFORMATION

Input Decoupling (C_{in})

A 2.2 μF capacitor either ceramic or tantalum is recommended and should be connected as close as possible to the pins of NCP706B device. Higher values and lower ESR will improve the overall line transient response.

Output Decoupling (C_{out})

The minimum decoupling value for NCP706BMX300TAG and NCP706ABMX300TAG devices is 2.2 μF. The regulator accepts ceramic chip capacitors MLCC. If a tantalum capacitor is used, and its ESR is large, the loop oscillation may result. Larger values improve noise rejection and PSRR.

Enable Operation

The enable pin EN will turn on or off the regulator. These limits of threshold are covered in the electrical specification section of this data sheet. If the enable is not used then the pin should be connected to V_{IN}.

Hints

Please be sure the V_{in} and GND lines are sufficiently wide. If their impedance is high, noise pickup or unstable operation may result.

Set external components, especially the output capacitor, as close as possible to the circuit.

The sense pin SNS trace is recommended to be kept as far from noisy power traces as possible and as close to load as possible.

Thermal

As power across the NCP706B/AB increases, it might become necessary to provide some thermal relief. The maximum power dissipation supported by the device is dependent upon board design and layout. Mounting pad configuration on the PCB, the board material, and also the

ambient temperature affect the rate of temperature rise for the part. This is stating that when the NCP706B/AB has good thermal conductivity through the PCB, the junction temperature will be relatively low with high power dissipation.

The power dissipation across the device can be roughly represented by the equation:

$$P_D = (V_{IN} - V_{OUT}) * I_{OUT} \text{ [W]} \quad (\text{eq. 1})$$

The maximum power dissipation depends on the thermal resistance of the case and circuit board, the temperature differential between the junction and ambient, PCB orientation and the rate of air flow.

The maximum allowable power dissipation can be calculated using the following equation:

$$P_{MAX} = (T_J - T_A) / \theta_{JA} \text{ [W]} \quad (\text{eq. 2})$$

Where (T_J - T_A) is the temperature differential between the junction and the surrounding environment and θ_{JA} is the thermal resistance from the junction to the ambient.

Connecting the exposed pad and non connected pin 3 to a large ground pad or plane helps to conduct away heat and improves thermal relief.

Overcurrent Latch Operation

The NCP706B/AB is equipped with latched overcurrent protection feature which will automatically disable the LDO in case of permanent output short circuit.

Initially during the OCP condition the current flowing from the input to the output of the LDO is typically 1.65 A. This current cause the die to heat-up and eventually when the temperature rises up to the thermal shutdown threshold the LDO becomes disabled. To resume the operation of the device it is necessary to toggle the EN to 'OFF' state and than back to 'ON' state again.

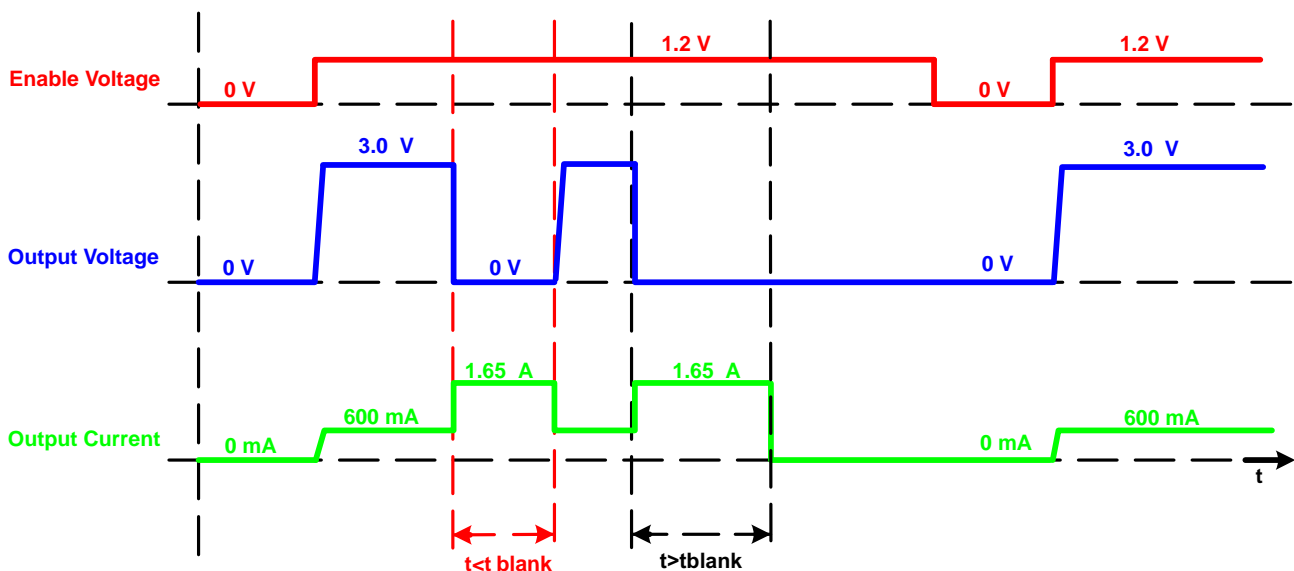

Figure 18. Overcurrent Latch Operation

NCP706B, NCP706AB

ORDERING INFORMATION

Device	Nominal Output Voltage	Marking	Active Discharge	Package	Shipping [†]
NCP706BMX300TAG	3.0 V	L3	No	XDFN8 (Pb-Free)	3000 / Tape & Reel
NCP706ABMX300TAG	3.0 V	CA	Yes		

[†]For information on tape and reel specifications, including part orientation and tape sizes, please refer to our Tape and Reel Packaging Specifications Brochure, BRD8011/D.

NCP706B, NCP706AB

PACKAGE DIMENSIONS

XDFN8 1.6x1.2, 0.4P
CASE 711AS
ISSUE O

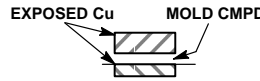
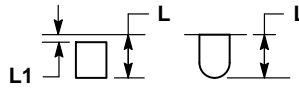
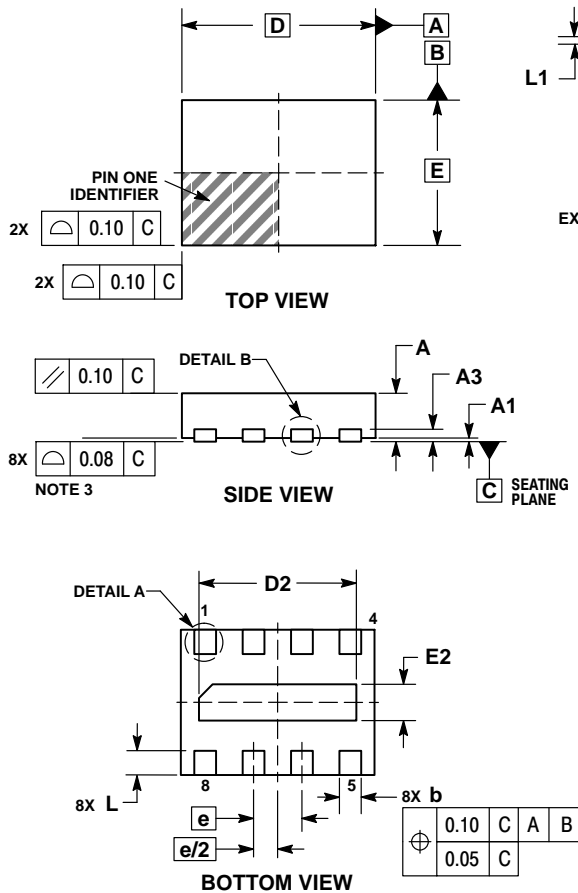

NOTES:

1. DIMENSIONING AND TOLERANCING PER ASME Y14.5M, 1994.
2. CONTROLLING DIMENSION: MILLIMETERS.
3. COPLANARITY APPLIES TO THE EXPOSED PAD AS WELL AS THE TERMINALS.

MILLIMETERS		
DIM	MIN	MAX
A	0.35	0.45
A1	0.00	0.05
A3	0.125 REF	
b	0.13	0.23
D	1.60 BSC	
D2	1.20	1.40
E	1.20 BSC	
E2	0.20	0.40
e	0.40 BSC	
L	0.15	0.25
L1	0.05 REF	

RECOMMENDED MOUNTING FOOTPRINT*

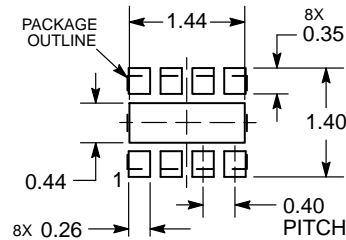

DIMENSIONS: MILLIMETERS

*For additional information on our Pb-Free strategy and soldering details, please download the ON Semiconductor Soldering and Mounting Techniques Reference Manual, SOLDERRM/D.

ON Semiconductor and the are registered trademarks of Semiconductor Components Industries, LLC (SCILLC) or its subsidiaries in the United States and/or other countries. SCILLC owns the rights to a number of patents, trademarks, copyrights, trade secrets, and other intellectual property. A listing of SCILLC's product/patent coverage may be accessed at www.onsemi.com/site/pdf/Patent-Marking.pdf. SCILLC reserves the right to make changes without further notice to any products herein. SCILLC makes no warranty, representation or guarantee regarding the suitability of its products for any particular purpose, nor does SCILLC assume any liability arising out of the application or use of any product or circuit, and specifically disclaims any and all liability, including without limitation special, consequential or incidental damages. "Typical" parameters which may be provided in SCILLC data sheets and/or specifications can and do vary in different applications and actual performance may vary over time. All operating parameters, including "Typicals" must be validated for each customer application by customer's technical experts. SCILLC does not convey any license under its patent rights nor the rights of others. SCILLC products are not designed, intended, or authorized for use as components in systems intended for surgical implant into the body, or other applications intended to support or sustain life, or for any other application in which the failure of the SCILLC product could create a situation where personal injury or death may occur. Should Buyer purchase or use SCILLC products for any such unintended or unauthorized application, Buyer shall indemnify and hold SCILLC and its officers, employees, subsidiaries, affiliates, and distributors harmless against all claims, costs, damages, and expenses, and reasonable attorney fees arising out of, directly or indirectly, any claim of personal injury or death associated with such unintended or unauthorized use, even if such claim alleges that SCILLC was negligent regarding the design or manufacture of the part. SCILLC is an Equal Opportunity/Affirmative Action Employer. This literature is subject to all applicable copyright laws and is not for resale in any manner.

PUBLICATION ORDERING INFORMATION

LITERATURE FULFILLMENT:
Literature Distribution Center for ON Semiconductor
P.O. Box 5163, Denver, Colorado 80217 USA
Phone: 303-675-2175 or 800-344-3860 Toll Free USA/Canada
Fax: 303-675-2176 or 800-344-3867 Toll Free USA/Canada
Email: orderlit@onsemi.com

N. American Technical Support: 800-282-9855 Toll Free USA/Canada
Europe, Middle East and Africa Technical Support: Phone: 421 33 790 2910
Japan Customer Focus Center Phone: 81-3-5817-1050

ON Semiconductor Website: www.onsemi.com
Order Literature: <http://www.onsemi.com/orderlit>
For additional information, please contact your local Sales Representative